

Quotation Request

询价函

Dear sir,

Our company, Power China Co., the Contractor of Construction of Model Schools (106 Nos) in DHIQAR, we are looking for qualified and experienced MDB supplier for this project, kindly submit your quotation if you are interested. The types of materials are listed below:

我公司，中国电建公司，为济加尔省 106 所示范学校建设项目的承包商，我们正在寻找有资质和经验的配电箱供应商，如果你感兴趣，请提交你的报价。材料清单如下：

No. 序号	Materials 名称	Specification 规格型号	Brand 品牌	Unit 单位	Quantity 数量	Unit Price/\$ 单价/美元	Amount/\$ 总价/美元	Remarks 备注
1	MDB 主配电箱	12B/12B1	ABB	Set	10			
2	MDB 主配电箱	18B2	ABB	Set	2			
3	MDB 主配电箱	18B/18B1	ABB	Set	10			
4	MDB 主配电箱	24B	ABB	Set	3			
5	MDB 主配电箱	24B1	ABB	Set	2			
Total								

Note:

1. The price shall include freight charge, handing charges, tax, if not, please specify.

价格应包括运费、手续费、税金，如不包括请注明

2. Payment terms: 100% of Contract Amount upon delivery to the site designated by the Buyer, and approved by the Buyer.

付款：送至买方指定地点，买方验收合格后支付进场数量的 100%；

3. Mode of payment: Wire transfer

支付方式：银行转账

4. Please indicate the validity of the offer.

请注明报价的有效性

5. Deadline for bidding document sale: 2024-03-04.

招标文件发售截止日期: 2024年03月04日

6. Deadline for accepting questions and replying: 2024-03-04.

答疑截止日期: 2024年03月04日

7. Contract bid opening date: 2024-03-06.

招标截止日期: 2024年03月06日

8. The bid opening time is the bid closing time.

开标日期: 为投标截止日期

9. Other issues which are necessary to be clarified.

其他需要澄清的问题



Attachment: Specification of MDB
 附件、MDB 主配电箱规格参数

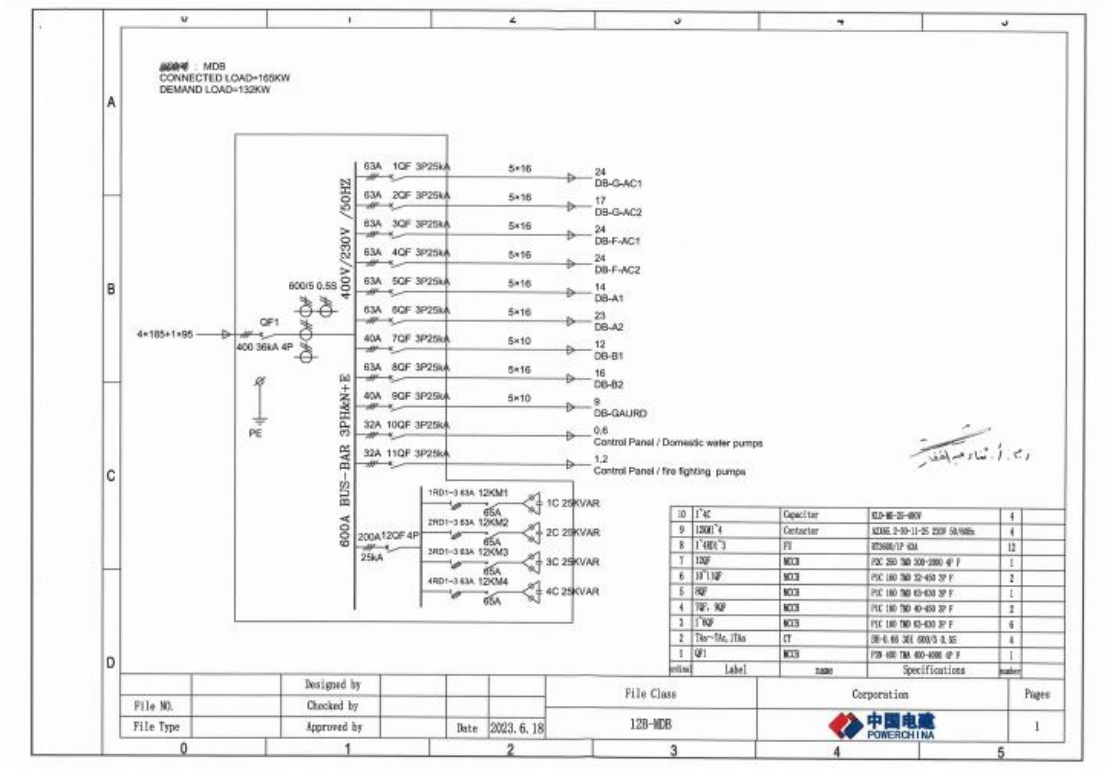
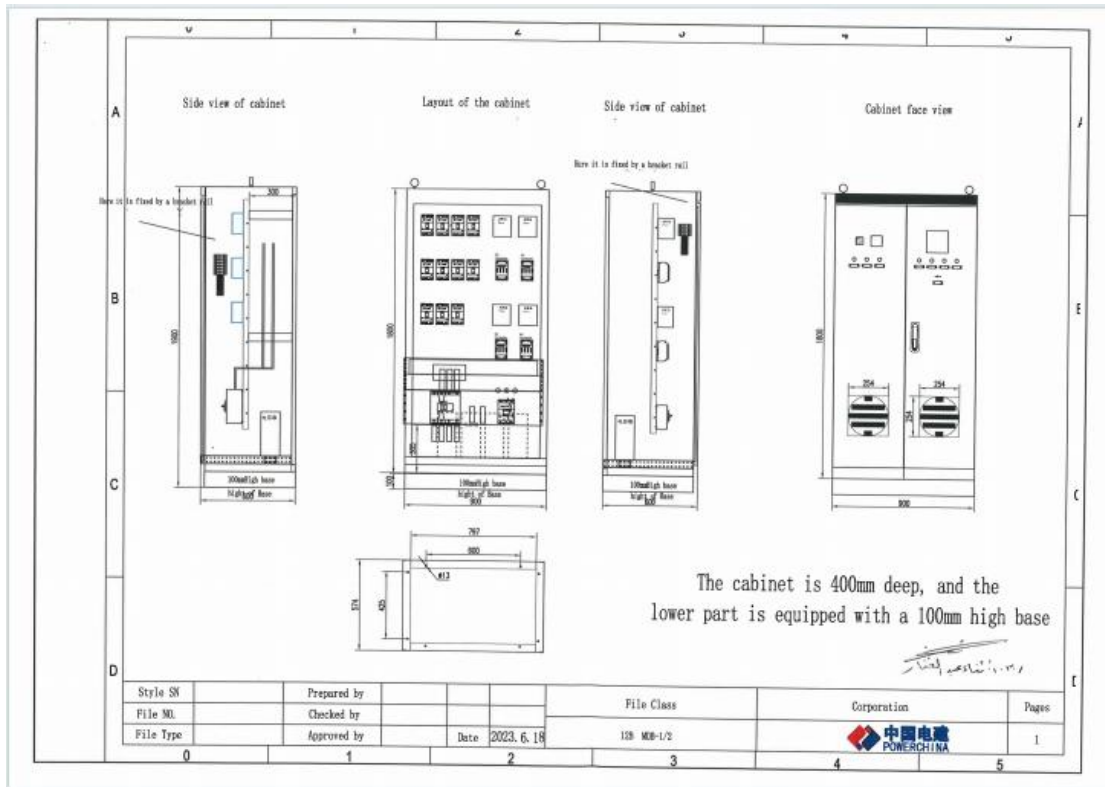

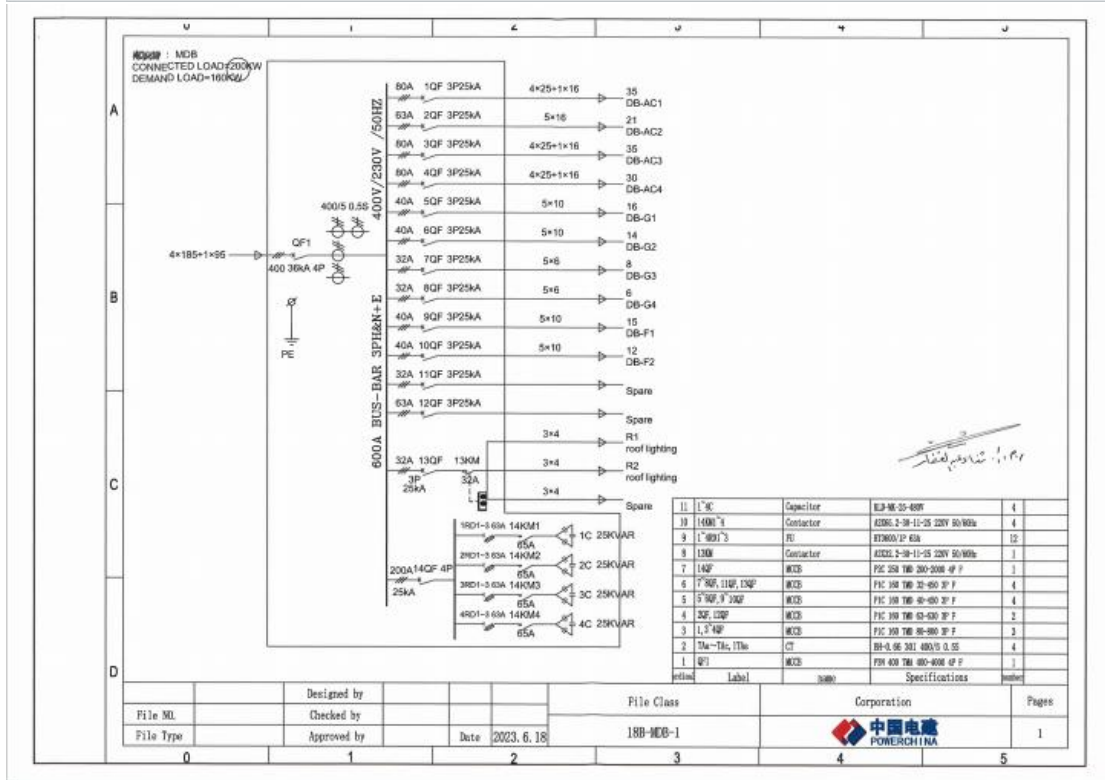
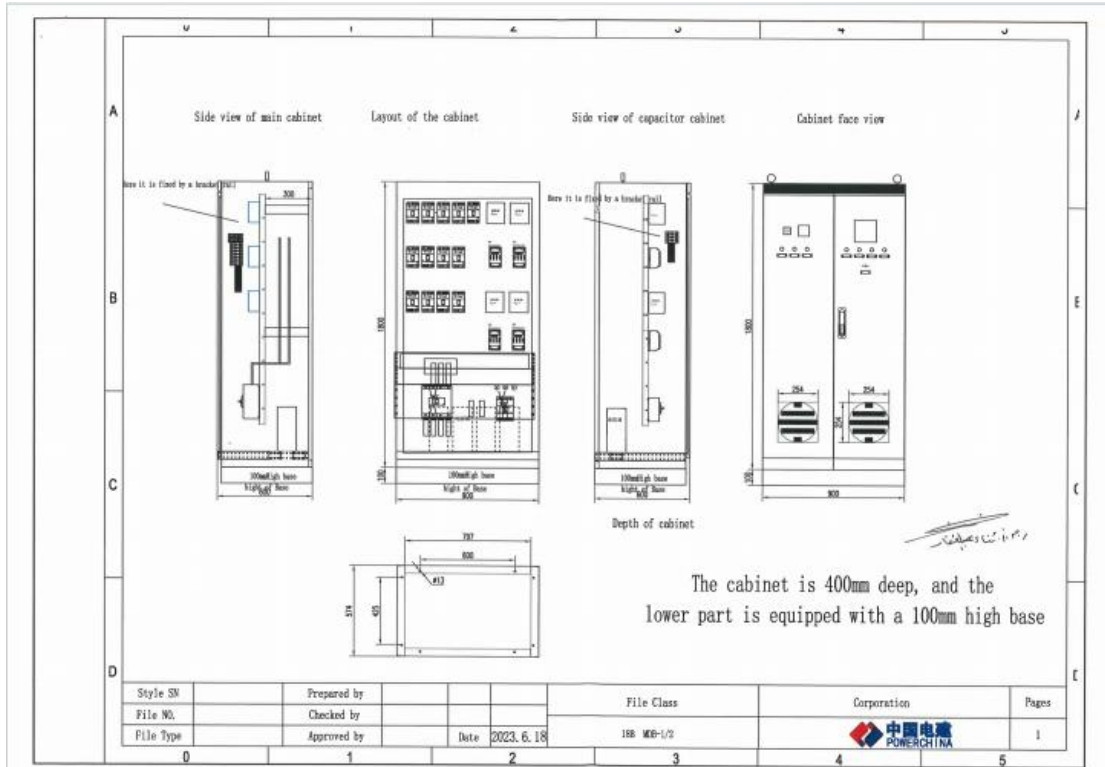

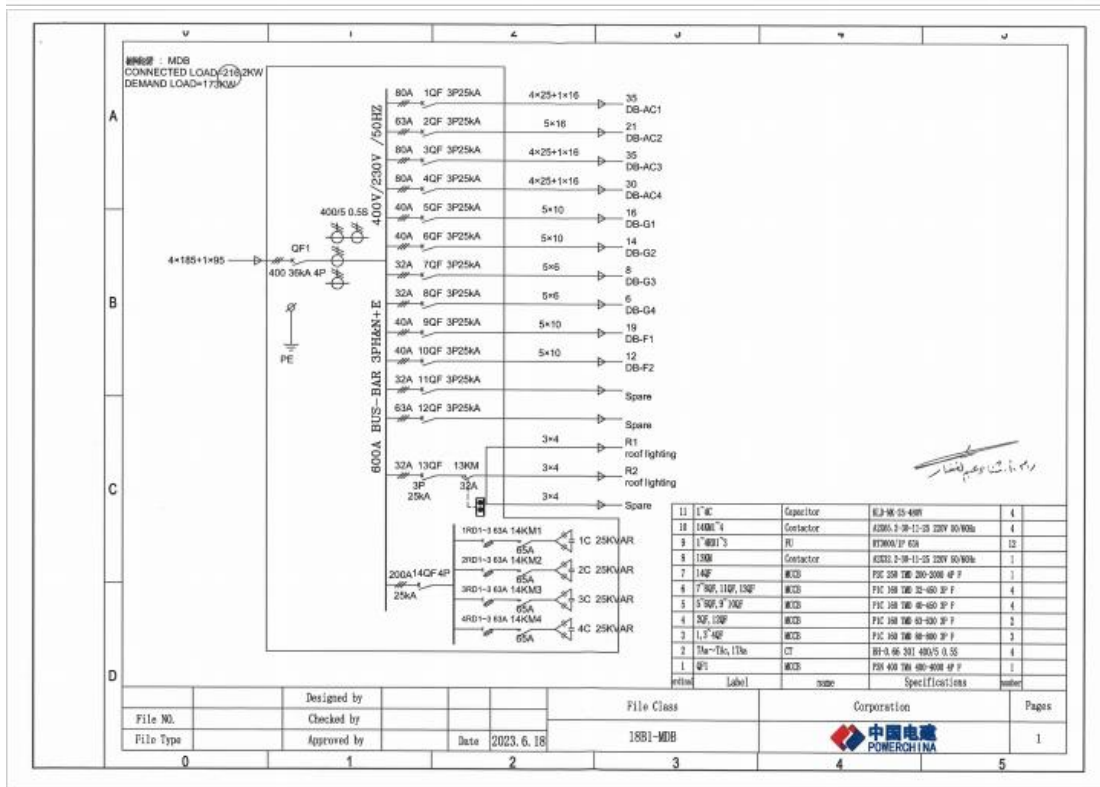
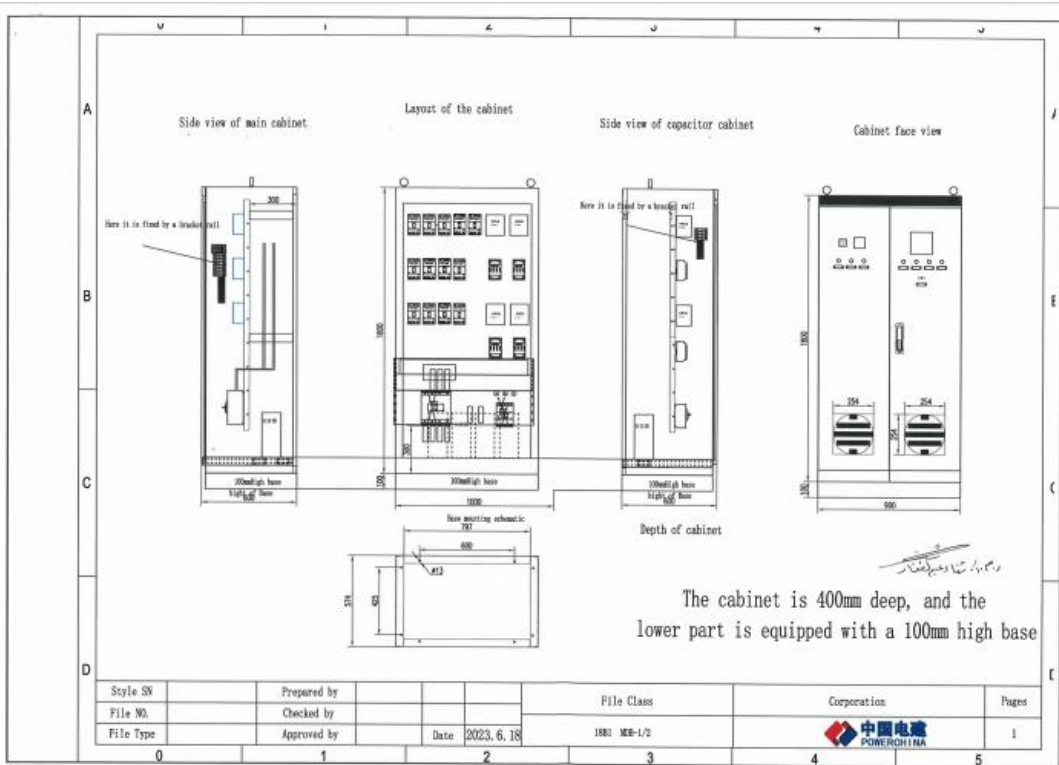

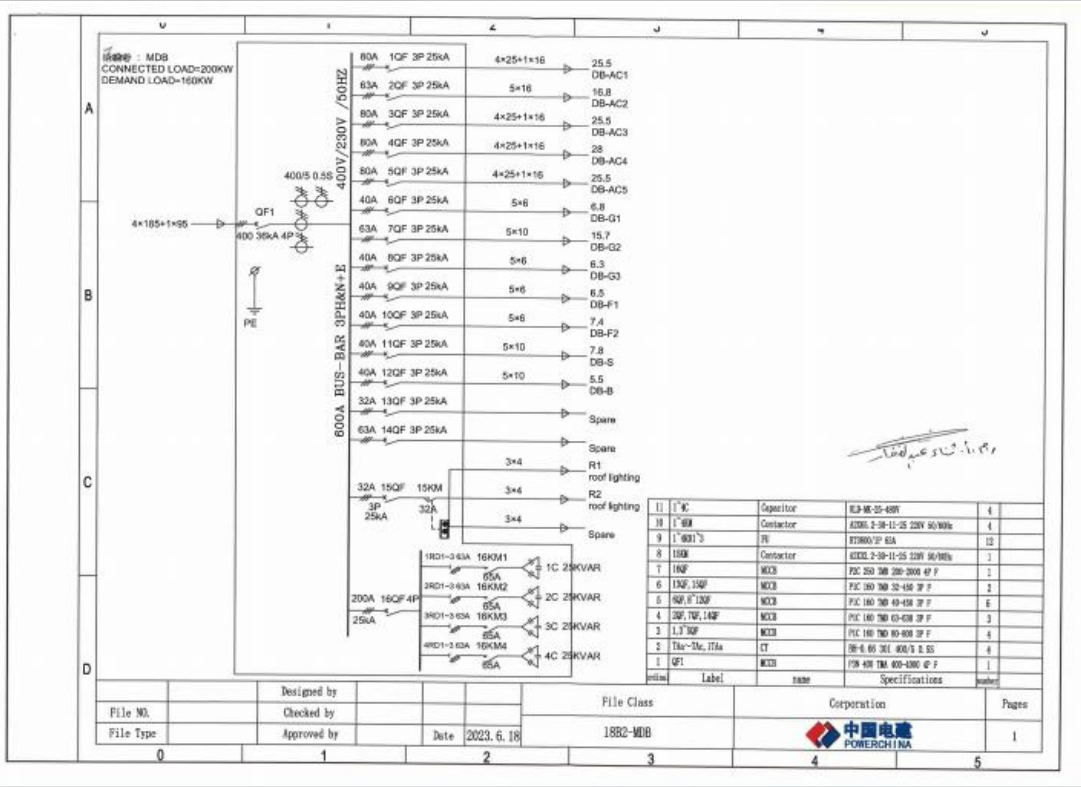
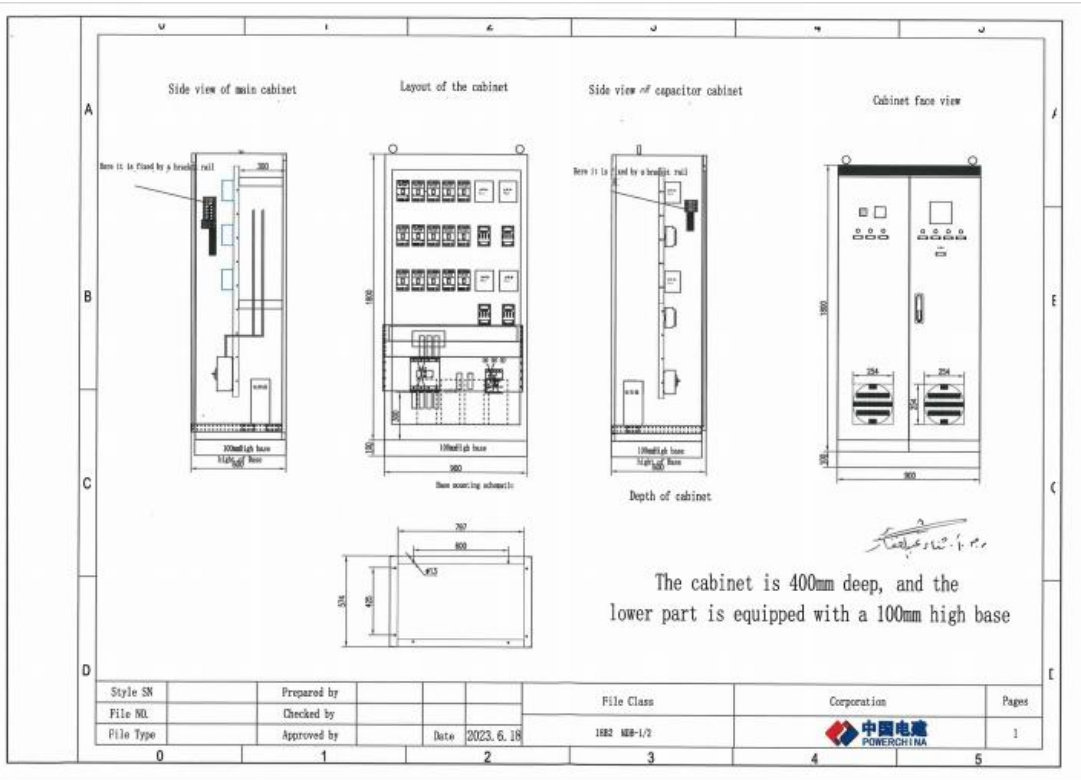

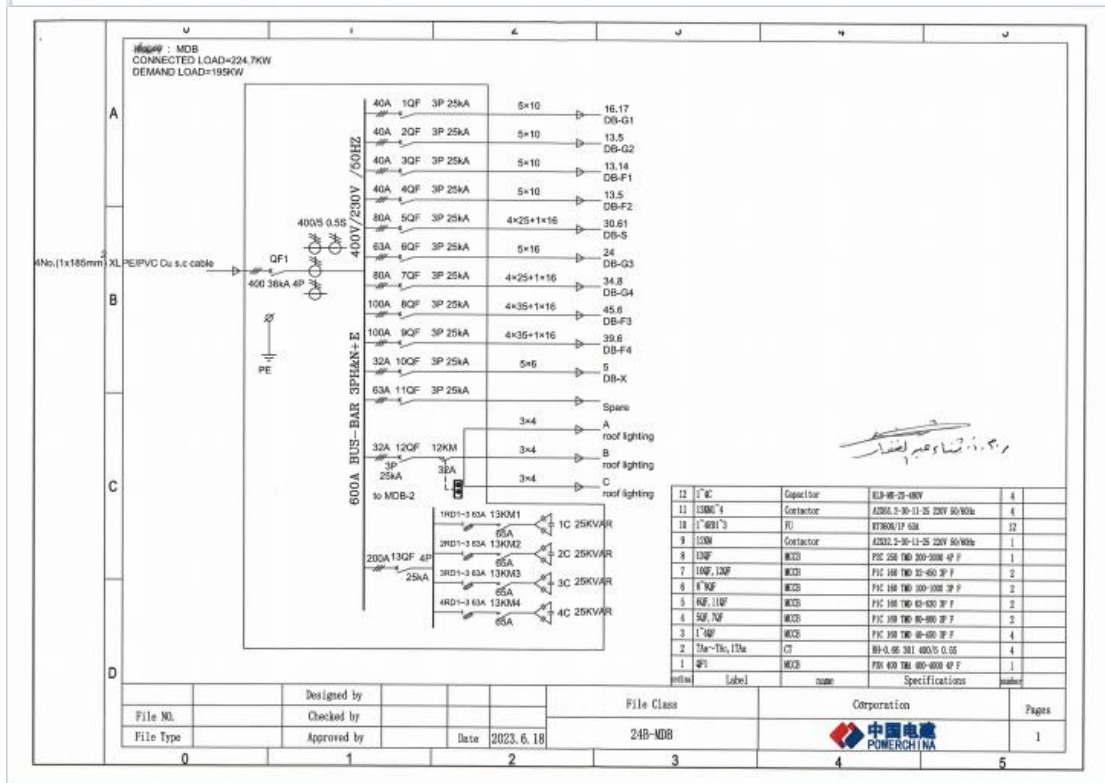
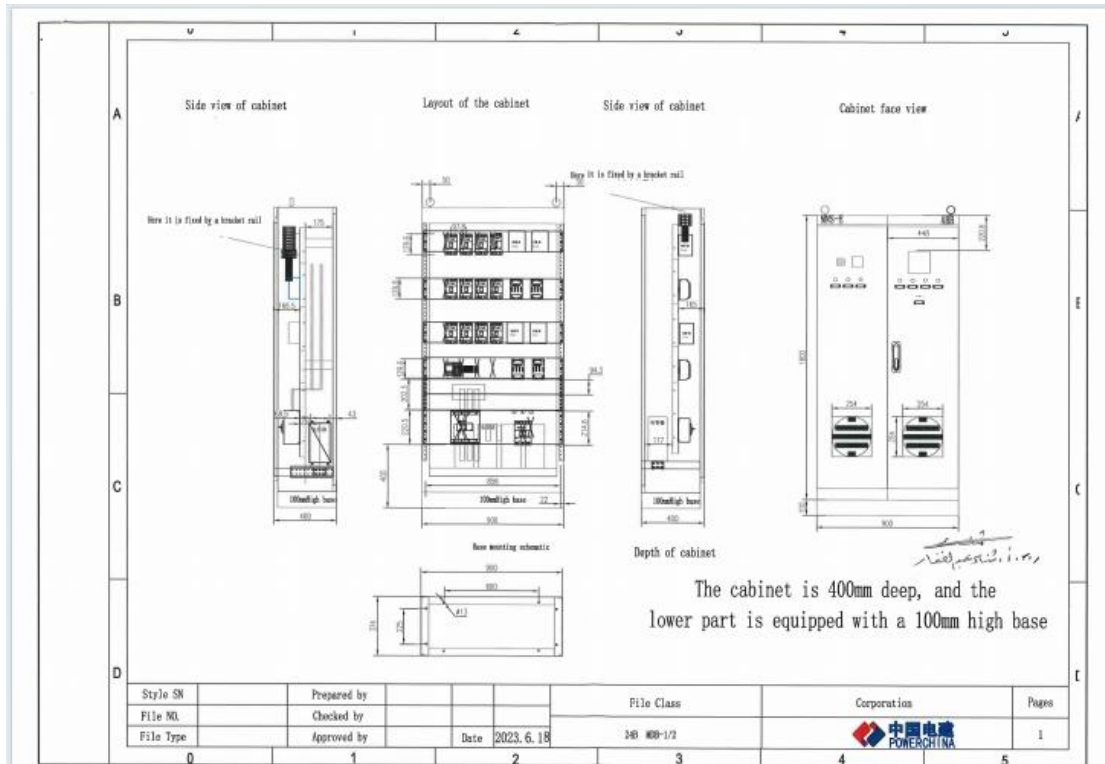

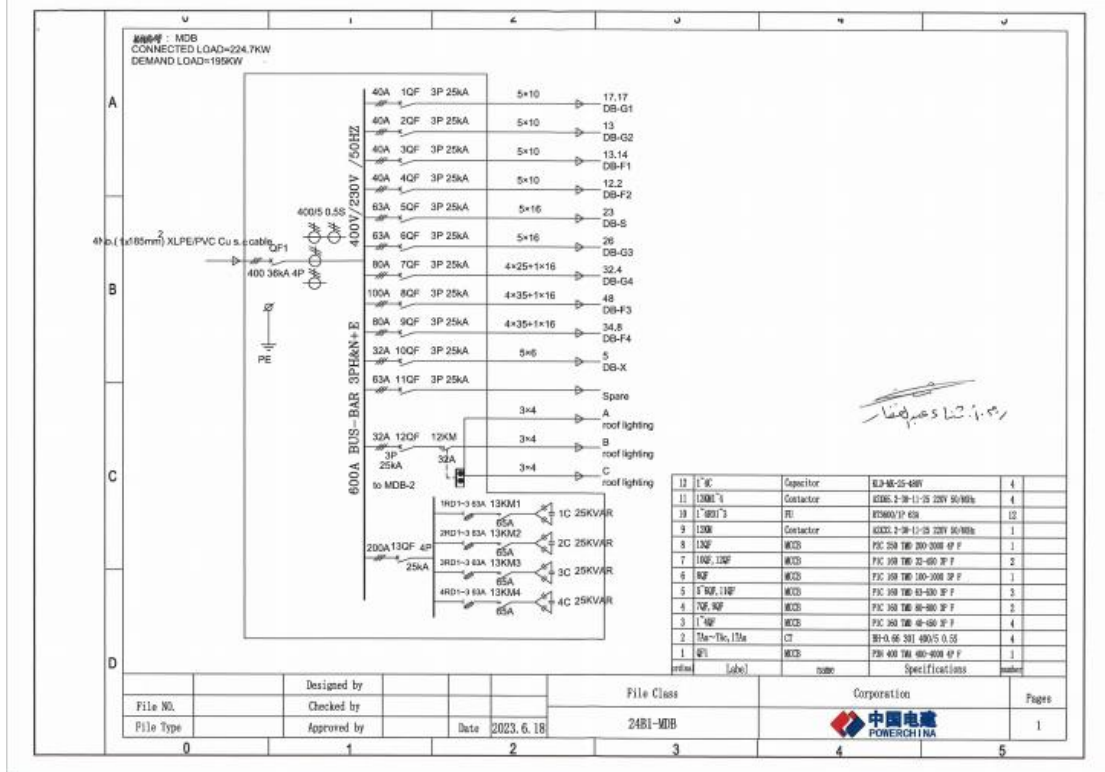
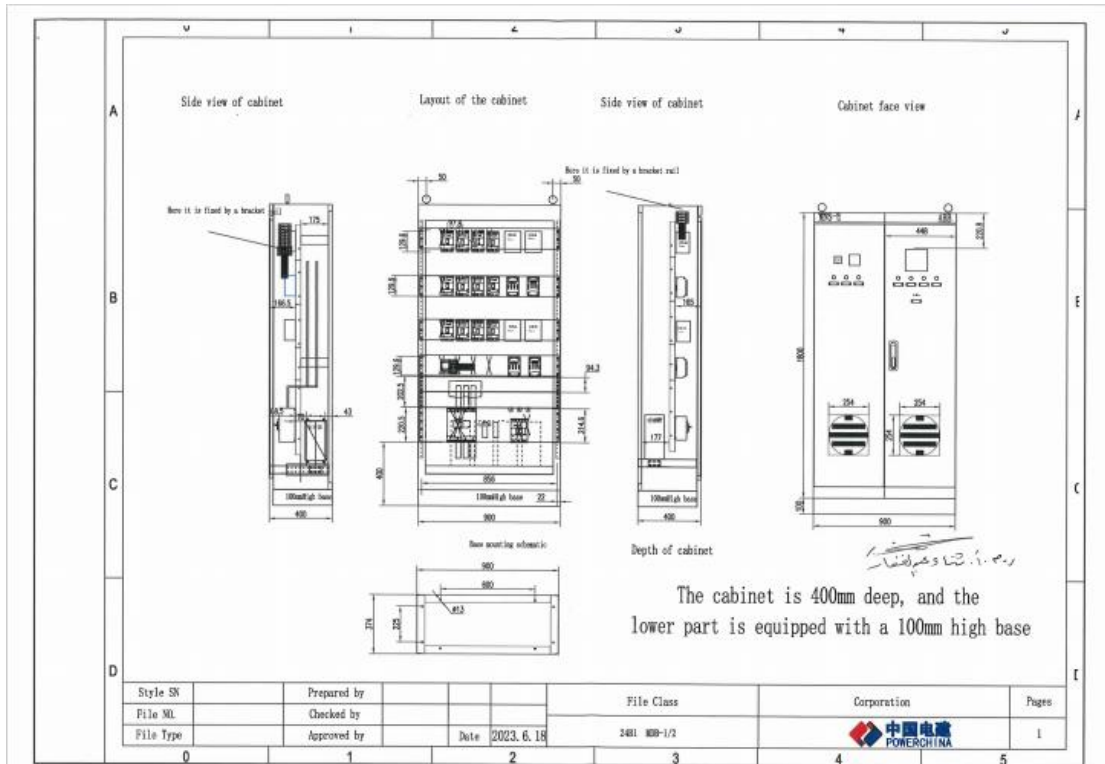

Attachment 四: Specification for final distribution boards(FDB)
 附近四：FDB 分配电箱规格参数

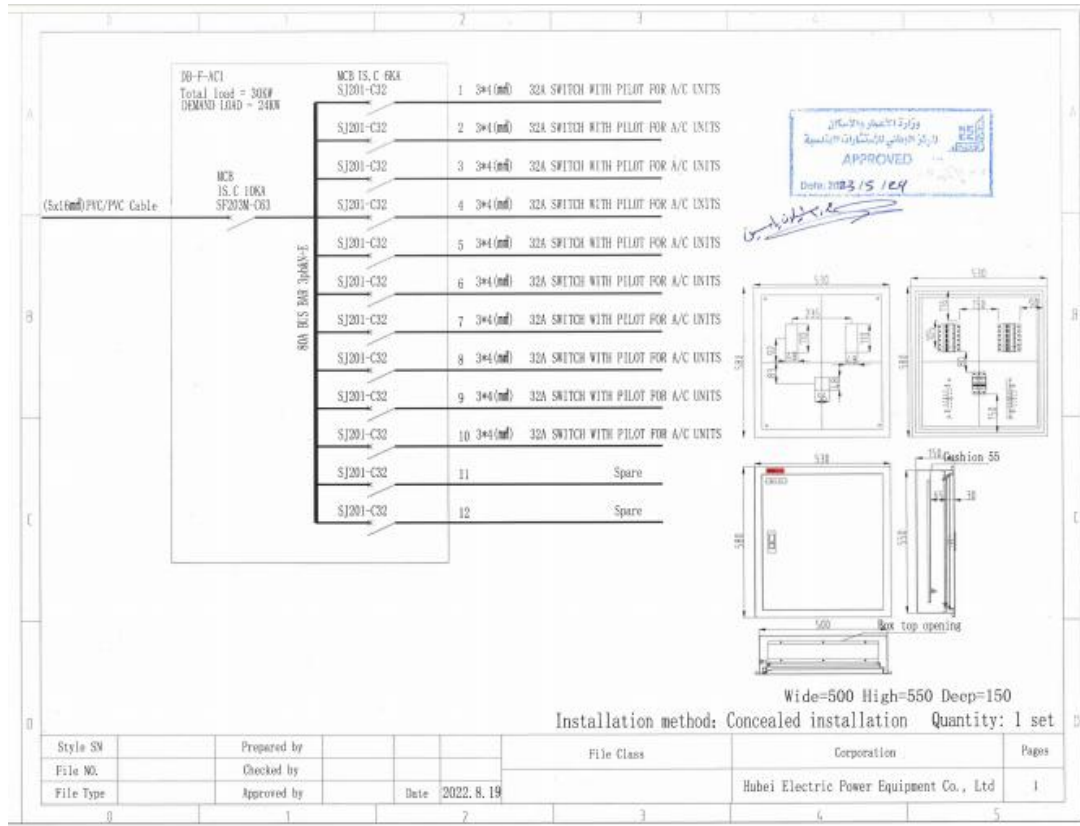

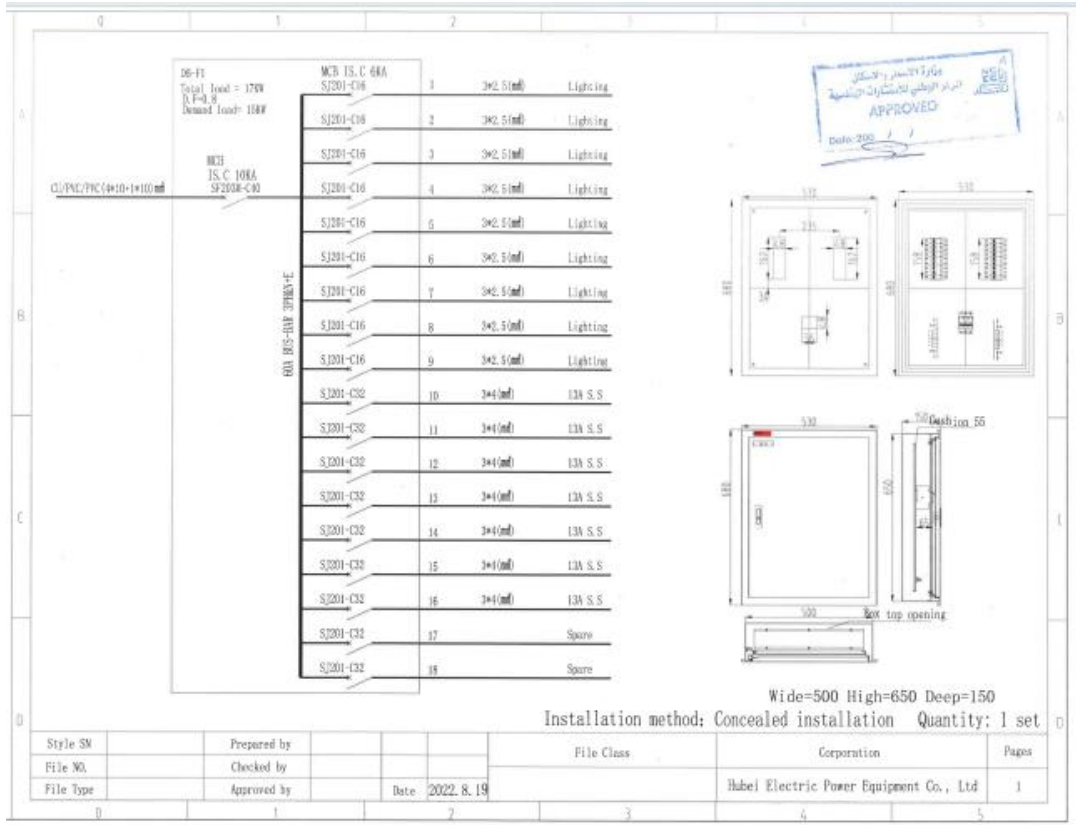

18B/18B1

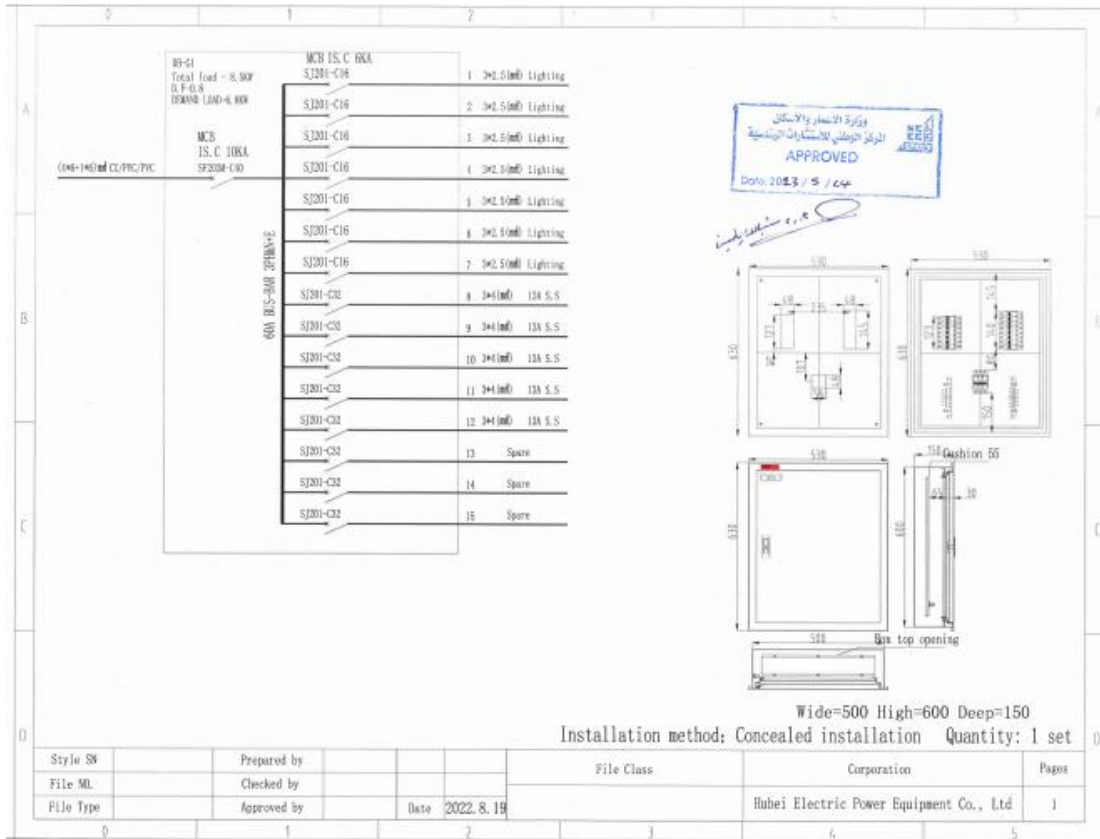

18B2

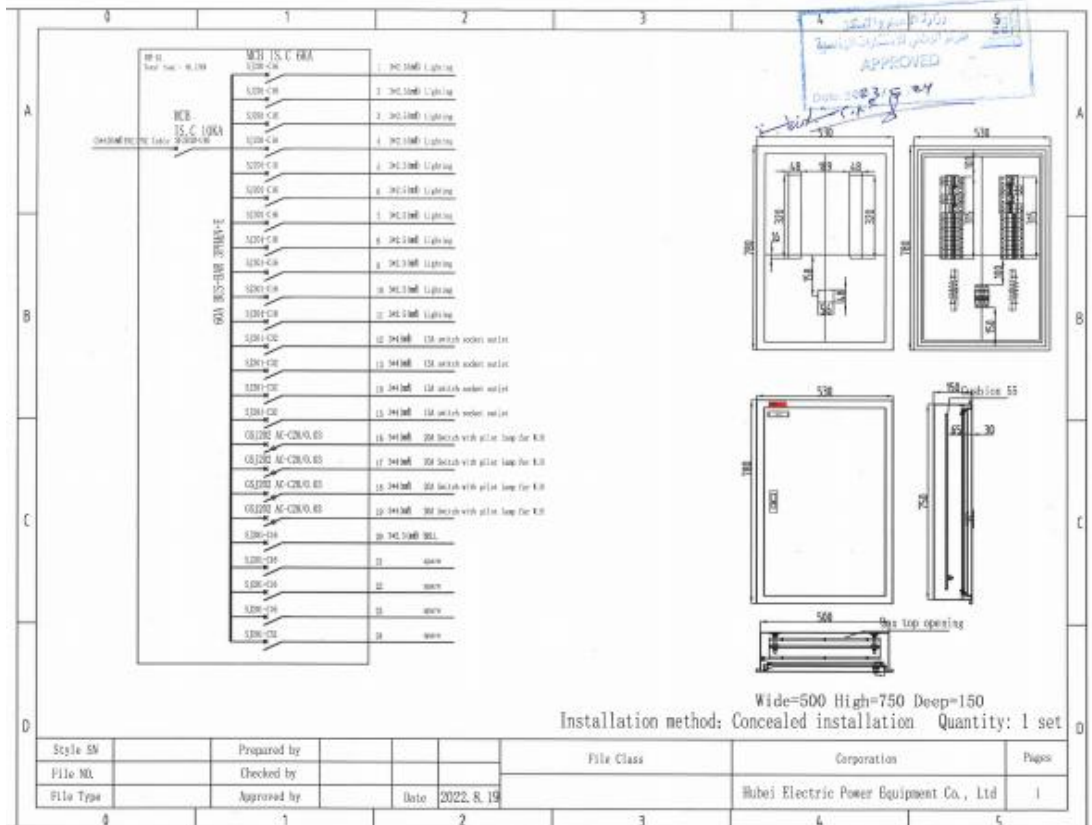

24B/24B1

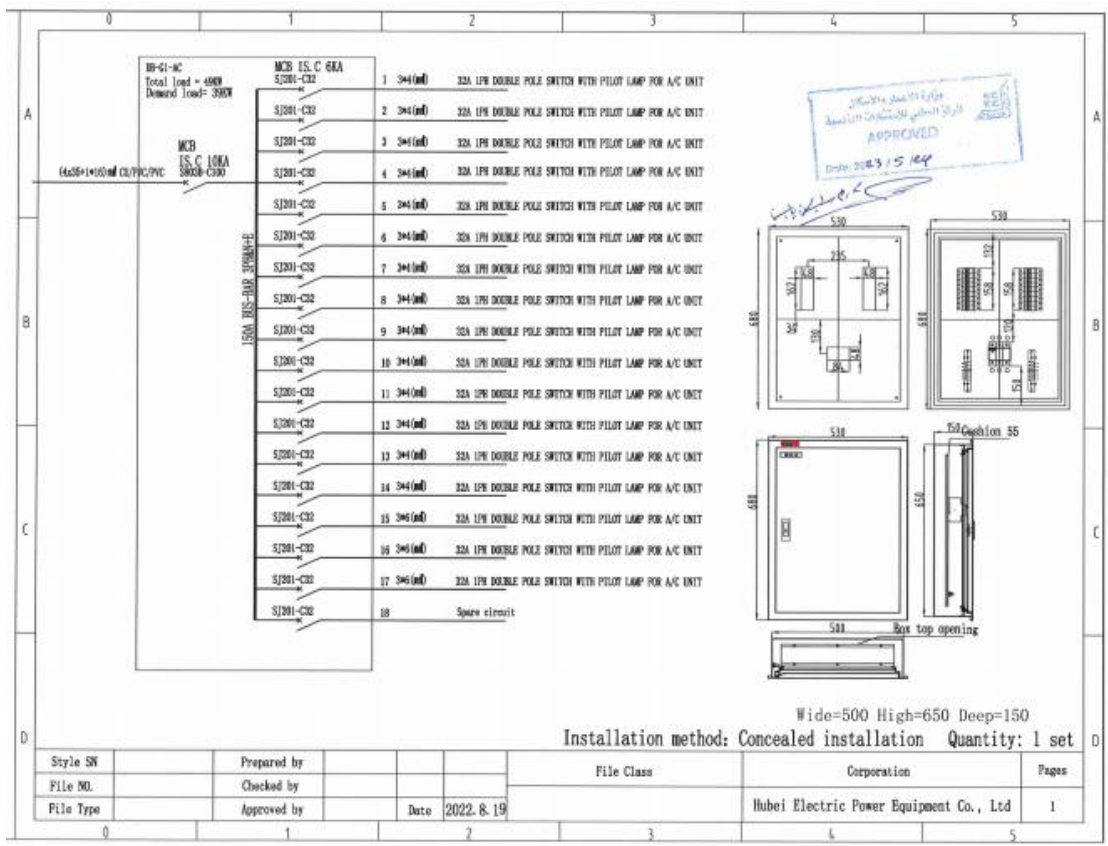

24A